

# Operator's Manual

1975 REVISION 1

# CUSHMAN<sup>®</sup> TRACKSTER

Marsh Model 898002



**SAFETY WARNING: NO PERSON SHOULD OPERATE A TRACKSTER BEFORE READING THIS MANUAL THOROUGHLY. IF ANY PORTION OF THIS MANUAL IS NOT CLEARLY UNDERSTOOD, WRITE US AT THE ADDRESS ON THE INSIDE COVER.**

## TRACKSTER MODEL 898002

This 1975 revision of the operator's manual supersedes all prior operator's manuals and all prior product advertising. Please discard the manual you received with your Trackster.

Please read this 1975 revision of the Trackster operator's manual carefully and immediately. The vehicle operating information on pages 3 through 12 should be studied by you and everyone who uses your Trackster. Note the safety warnings and comply with them to help avoid injury to yourself or others.

Your Trackster dealer is where to go for parts and service. If no Trackster dealer is available to you, please contact us directly.

This manual refers to a sprocket lock. The sprocket lock is a new system available at no cost to you for materials or labor. It will be installed by any Trackster dealer upon request.

Cushman Motors Division of Outboard Marine Corporation reserves the right to make design and specification changes, additions and improvements, in its products without notice and without incurring obligation to install them on products already manufactured.

## SERVICE PUBLICATIONS

Additional Owner's Manuals, as well as illustrated Parts Books and Service Manuals, are available from the Trackster Service Department, OMC - Lincoln, P. O. Box 82409, Lincoln, Nebraska 68501. A minimum charge is made for these publications; prices are available on request. **Always give the VEHICLE MODEL AND SERIAL NUMBER** when requesting publications.

### PRE-START CHECK LIST

Each time the Trackster is to be used the operator should walk around the vehicle to make a visual check to ensure all operating parts are in order.

1. Check gasoline/oil mixture level. This is especially important if the vehicle is to be operated in rough terrain or remote areas.
2. Check transmission oil level. Low oil level or incorrect oil mixture may cause hydraulic system failure.
3. Check sprocket lock. When engine is not running the pin should be extended to engage drive sprocket teeth. All nuts and bolts should be in place and tight.
4. Check drive sprockets for wear, missing or bent teeth.

# INDEX

	Page		Page
Adjustments		Model Identification	2
Breaker Points	14	Operation	4
Carburetor	15	Operating Safety Precautions	11
Governor	15	Owner's Responsibility	2
T-Handle	18	Replacement Parts	2
Tracks	18	Safety	2
Air Cleaner	16	Serial Numbers	2
Battery	17	Specifications	1
Carburetor	15	Sprocket Lock	3
Controls	3	Starting the Engine	12
Fuel System	16	Storage	19
Fuel Recommendations	12	Trouble Shooting	Back Cover
Ignition System	13	Warranty	Back Cover
Introduction	2	Warranty Service	2
Maintenance		Water Operation Section	21
Engine	13	Wiring Diagram	21
Fuel System	16		
Governor	15		
Transmission	18		

© Outboard Marine Corporation 1975. All rights reserved. Printed in U.S.A.

# SPECIFICATIONS

## ENGINE

Bore	2 3/4"
Stroke	2 1/4"
Piston Displacement	26.7 cu. in. (437 c.c.)
Horsepower	25 or 29 at 5000 RPM
Spark Plug	Champion J2J or equivalent
Spark Plug Gap	.035 to .040
Carburetor Adjustment	
High Speed	approx. 1 1/8 turn open
Low Speed	5/8 turn open
Breaker Point Gap	.020-.022
Lubrication	50:1 gasoline to oil mixture

## CAPACITIES

Fuel Tank	10 U.S. gallon
Transmission 1974 & Earlier	7 quarts
Transmission Oil	4 Quarts of Arctic Oil (Mil. Spec. 5606, use Mobil Aero HFA or Texaco Aircraft Hydraulic Oil AA or BB) and 3 Quarts of Type "F" Automotive Transmission Fluid
1975 & Later	
Transmission	8 quarts (4 qts. Arctic Oil — 4 qts. Type "F")

## BATTERY

Volts	12
Ampere-hour Rating	67
Ground Terminal Polarity	Negative
Terminals	Standard taper

WEIGHT ..... 1170 lbs.

CAPACITY ..... 800 lbs.

## GROUND PRESSURE

Dry unloaded ..... 0.55 P.S.I.

HEIGHT ..... 41"

LENGTH ..... 92"

WIDTH ..... 62"

TRANSMISSION ..... Sunstrand Model 90-1025/26



# SAFETY

THE PURPOSE OF SAFETY SYMBOLS IS TO ATTRACT YOUR ATTENTION TO POSSIBLE DANGERS. THE SYMBOLS, AND THE EXPLANATIONS WITH THEM, DESERVE YOUR CAREFUL ATTENTION AND UNDERSTANDING. SAFETY WARNINGS DO NOT BY THEMSELVES ELIMINATE ANY DANGER: THE INSTRUCTIONS OR WARNINGS THEY GIVE ARE NOT SUBSTITUTES FOR PROPER ACCIDENT PREVENTION MEASURES.



**SAFETY WARNING: FAILURE TO OBEY A SAFETY WARNING MAY RESULT IN INJURY TO YOU OR TO OTHERS.**



**NOTE: ADVISES YOU OF INFORMATION OR INSTRUCTIONS VITAL TO THE OPERATION OR MAINTENANCE OF YOUR EQUIPMENT.**

# INTRODUCTION

Your Cushman vehicle is the result of over half a century of experience in designing and engineering vehicles for industry and pleasure. With proper care, your Trackster will give the same long, dependable service that Cushman vehicles have given in the past.

The Trackster features flexible, one-piece molded rubber tracks for maximum traction and minimum ground pressure, a low center of gravity for stability and ample room for two passengers and equipment. The ultimate in handling ease is provided by a single T-handle which controls the speed, direction and braking of the vehicle, when the engine is operating.

Power is supplied by an OMC 25 or 29 horsepower die-cast aluminum, air-cooled, two-cycle, electric-start engine.

The engine is connected to the axle through a flexible coupling, and two hydrostatic transmissions which enable each track to be controlled independently.

## MODEL IDENTIFICATION

### Vehicle Model and Serial Numbers

The vehicle model number is stamped on the nameplate located on the trim just below the right handhold. The vehicle serial number is stamped in the trim below the nameplate. Refer to both numbers in all correspondence concerning your vehicle and when ordering replacement parts.

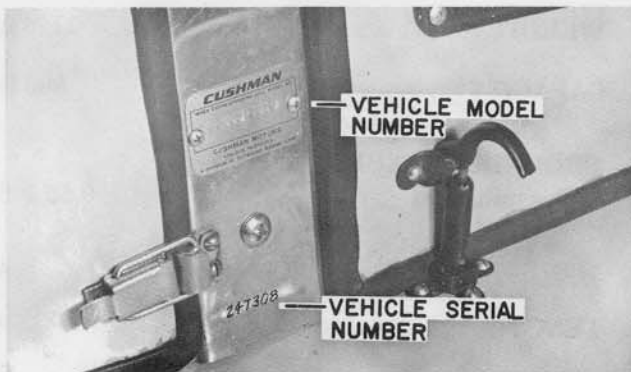

## REPLACEMENT PARTS

The Trackster dealer organization can supply service and replacement parts.

If no Trackster dealer is available, write to us at the address on the inside front cover.

## WARRANTY SERVICE

Should your Trackster require service which appears to be under warranty, take it to your authorized Cushman Trackster Dealer. He will make the necessary repairs and return the parts to the factory with a completed Warranty Request.

The following points should be followed when requesting a warranty repair:

1. All warranty work must be performed by an authorized Cushman Trackster Dealer.

2. Warranty Service can be obtained from any authorized Dealer, however, it is best to have the work performed by the Dealer who originally sold the vehicle.

### ITEMS NOT COVERED BY WARRANTY

Provisions of the warranty will not apply to:

1. Vehicles subjected to misuse, accident, neglect, alterations, or used for racing purposes.

2. Pickup and delivery of vehicle, mechanics travel time, and removal of non-Cushman accessories.

3. Used or secondhand vehicles. The warranty applies to the original purchaser only.

4. Damage to tracks or suspension system due to excessive operation on hard, paved surfaces.

5. Damage due to impact, upset or towing.

## OWNER'S RESPONSIBILITY

Normal maintenance service and replacement of service items are the responsibility of the owner and such are not considered defects in material and workmanship within the terms of the Warranty. Individual operating habits and usage contribute to the need for maintenance service.

To validate the warranty it is the owner's responsibility to:

1. Provide correct recommended fuel mixture.

2. Maintain all components in proper adjustment.

3. Have all recommended services performed as required.

Normal maintenance services are:

1. Adjustments

2. Tune-up

3. Air Cleaner Service

Service items not covered by the warranty are:

1. Spark Plugs

2. Ignition Points

3. Belts

# CONTROLS

Read this section carefully and try each control on your vehicle before attempting to operate it.

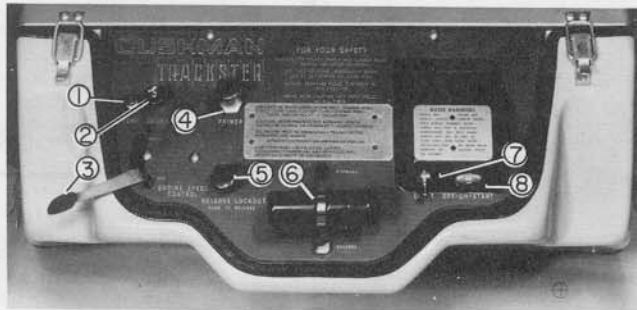

- |                       |                    |
|-----------------------|--------------------|
| 1. Temperature Light  | 5. Reverse Lockout |
| 2. Choke              | 6. T-Handle        |
| 3. Engine Speed Lever | 7. Light Switch    |
| 4. Primer             | 8. Ignition Switch |

## Engine Speed Control

The thumb-operated lever is located on the left side of the control panel. The lever adjusts the engine governor to provide a constant engine speed. The vehicle speed can also be controlled by this lever.

## Light Switch

The Trackster is equipped with two sealed beam headlights and a tail light. Pull the switch out to turn the lights on.

## Ignition Switch

The ignition switch can be operated only with the proper key. The switch has **ACCESSORY**, **OFF**, **ON** and **START** positions.

## Primer

The primer is used to manually pump fuel into the crankcase prior to starting a cold engine.

## Choke

The choke is used during starting and engine warm-up to enrich the fuel supply to the engine.

## Temperature Light

This red warning light will illuminate when the transmission oil reaches a temperature above normal. Do not operate the vehicle with the warning light on.

If the oil light comes on while the vehicle is in operation, stop the vehicle and run the engine at approximately half throttle until the light goes off. Check for obstructed air passages. Do not operate the vehicle with the air shrouds and engine covers removed.

## T-Handle

This handle controls the vehicle speed, direction and braking, **ONLY WHEN THE ENGINE IS RUNNING**. It has **REVERSE**, **STOP** and **FORWARD** positions. Twisting the T-handle to the left or right causes the vehicle to move in that direction.



**SAFETY WARNING: CORRECT T-HANDLE ADJUSTMENT IS CRITICAL TO SAFE VEHICLE OPERATION. INCORRECT ADJUSTMENT CAN CAUSE ERRATIC VEHICLE RESPONSE AND POSSIBLE TIPOVER.**

## Manual Starter

If the electric starter should not function, the rewind manual starter can be used. The engine cover must be removed for access to the starter handle.

## Reverse Lockout

The lockout must be depressed before the T-Handle can be moved to the reverse position.

## Fuel Gauge [Not Illustrated]

The fuel gauge and fuel tank cap are one unit. The gauge is self-actuating and does not require electrical power. The gauge indicates the amount of fuel left in the tank. A more accurate measure is made when the vehicle is on a level surface.

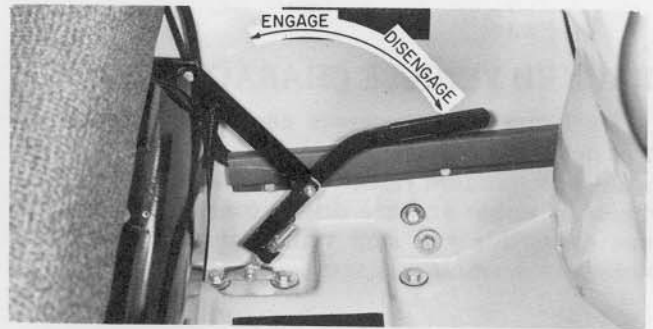

## Parking Brake [Shown above]

The lever located to the left of the seat operates the parking brake. Pull the lever up to engage the brake.



**SAFETY WARNING: DO NOT RELY ON THIS PARKING BRAKE. [See Pg. 11]**

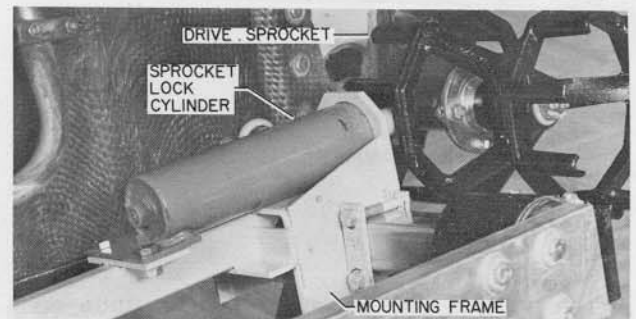

## Automatic Sprocket Lock

This lock is located directly behind the right drive sprocket. It disengages automatically when hydraulic pressure reaches operating level, and engages when the hydraulic pressure drops.

# OPERATION

A tracked vehicle, by its very nature, requires the use of operating techniques and procedures that are unfamiliar to most people used to driving wheeled vehicles.

This means that a person intending to operate a Trackster must allow himself ample opportunity to familiarize himself with the controls and characteristics of the machine.

It is the purpose of this section to inform and instruct prospective Trackster operators in an effort to help them to use it safely.



**SAFETY WARNING: NO PERSON SHOULD ATTEMPT TO OPERATE A TRACKSTER BEFORE READING THIS SECTION THOROUGHLY. IF ANY PORTION OF THIS SECTION IS NOT CLEARLY UNDERSTOOD, WRITE TO US AT THE ADDRESS ON THE INSIDE FRONT COVER.**

## TRACKED VEHICLE CHARACTERISTICS

Tracked vehicles possess certain inherent features not found on standard four-wheel vehicles. For instance, a standard vehicle will hit bottom when the wheels on either end are driven over a drop-off. In most cases this will stop vehicle motion and give immediate warning.

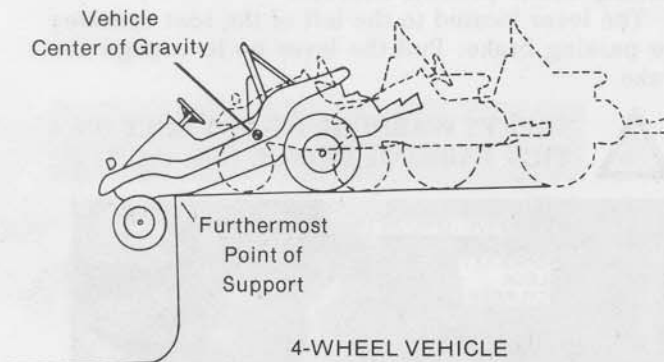

A tracked vehicle, however, will continue on without any warning until its center of gravity passes across an imaginary line drawn straight up from the furthest point of support with the ground. It will then drop **SUDDENLY**. (See illustration upper right). **THIS WILL HAPPEN EVEN AT THE VERY SLOWEST SPEEDS.**

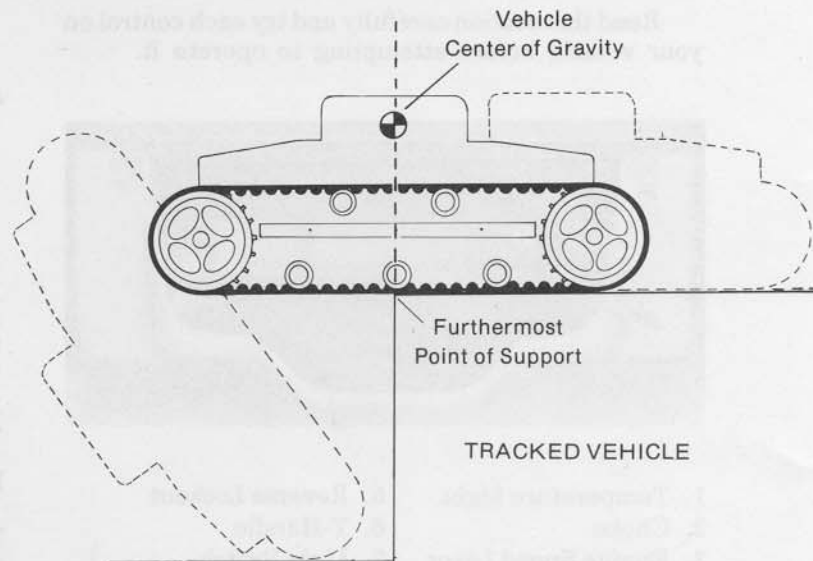

**SAFETY WARNING: ANYTIME A PORTION OF THE TRACK IS NOT IN CONTACT WITH THE GROUND, STABILITY IS REDUCED. NEVER ATTEMPT TO "JUMP" A TRACKED VEHICLE OVER DROP-OFFS, HILL CRESTS, OR OTHER OBSTACLES. THIS CAN BE EXTREMELY HAZARDOUS.**

A tracked vehicle can climb or descend steep slopes, so steep in fact that the vehicle can tip over, forward or backward, before it loses traction.

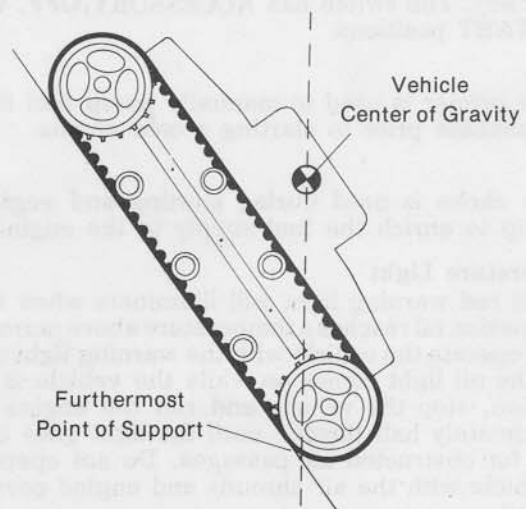

Tipover occurs when the vehicle's center of gravity passes across an imaginary line drawn straight up from the furthest point of support with the ground.

When the vehicle's center of gravity passes this point, the vehicle will tip over **SUDDENLY**.



## TRACKSTER OPERATION

The Trackster, by its very nature, is a vehicle requiring a great degree of care and judgment during operation. It should be kept in mind that while the Trackster is designed to operate in rough terrain, this same fact allows for the possibility of a hazardous condition developing at any time. Safe operation of the Trackster must be based on the understanding of the vehicle's limitations, thorough knowledge of the controls and their functions, and the operator's good judgment and experience.



**SAFETY WARNING: WHERE THE OPERATOR IS NOT CERTAIN OF THE VEHICLE'S ABILITY TO TRAVERSE AN OBSTACLE OR TERRAIN SITUATION, OR, IS NOT CERTAIN OF HIS OWN ABILITY TO SAFELY OPERATE THE VEHICLE, AN ALTERNATE ROUTE MUST BE TAKEN.**

### VEHICLE CONTROL SYSTEM [T-Handle]

The vehicle will react directly in proportion to the movement of the T-handle; i.e., an erratic jerking motion on the T-handle will provide that type of vehicle motion. Hold the T-handle lightly and move it slowly whenever possible.

**STOP:** This position prevents movement of the tracks when the engine is running. Gradual return of the T-handle to this position will provide a smooth stop.



**SAFETY WARNING: THE T-HANDLE CONTROLS THE VEHICLE ONLY WHEN THE ENGINE IS RUNNING.**

**FORWARD:** Moving the handle forward starts the vehicle moving forward. As the handle is advanced, the vehicle speed increases. Move the handle forward slowly to allow the engine time to respond. Thrusting the handle forward quickly will offer a situation similar to rapidly releasing the clutch on an automobile. Power is demanded too quickly and the engine is stalled. The terrain being traveled and vehicle load will determine how far the T-handle can be advanced. As the engine begins to lose RPM or "lug down," pull the T-handle back slowly until the engine returns to its original speed. This procedure simulates shifting to a lower gear in a conventional transmission, the vehicle speed is decreased and more torque is supplied to the drive system. The T-handle must be continually employed as the terrain changes. Always try to maintain a constant engine RPM. Allow the engine to "run freely," avoid overworking or "lugging" the engine. In severe terrain conditions, (deep snow, marsh, etc.) it may not be possible to operate the vehicle with T-handle fully advanced.

**REVERSE:** Depress the Reverse Lockout and pull the T-handle back. Turn by twisting the handle, counterclockwise to back to the right, clockwise to back to the left.

**STOPPING:** Braking of the Trackster WHILE UNDERWAY is provided by—and only by—the hydrostatic transmission which drives or stops the tracks in response to motion of the T-handle control. The hydrostatic transmission provides braking capability not only when the engine is running but also immediately following an unexpected engine stoppage.

After the engine has stopped and the vehicle has been stationary for a short time, the oil pressure in the hydrostatic transmission will drop to a point where the transmission ceases to provide braking action. The actual length of time will vary from a few seconds to a few minutes depending on the steepness of the slope and the condition of the hydrostats.



**SAFETY WARNING: THE FOLLOWING CONDITIONS REQUIRE SPECIAL CAUTION WHILE OPERATING THE TRACKSTER.**

1. **UNFAMILIAR TERRAIN:** Snow, tall grass, shrubs, etc., can hide dangerous obstacles.
2. **ICE:** Never attempt to cross a frozen body of water unless you are sure the ice will support the vehicle's weight. Be sure to allow for the extra weight of passengers and accessories.
3. **HILL CRESTS:** If you are unsure of the terrain on the other side, come to a complete stop and visually check the area before continuing.
4. **DROPOFFS:** Dropoffs small enough to be safely negotiated should be approached very slowly and should be attempted from a standstill.



**SAFETY WARNING: NEVER ATTEMPT TO "JUMP" THE VEHICLE OVER DROPOFFS, HILL CRESTS, OR ANY OBSTACLES. THIS CAN BE EXTREMELY HAZARDOUS TO OPERATOR AND/OR PASSENGERS AND WILL ALMOST CERTAINLY CAUSE EXTENSIVE VEHICLE DAMAGE.**

5. **WATER OPERATION:** Refer to special Water Operation Section on Page 21.

## 6. OPERATION ON SLOPES:

Trackster operation on slopes presents an obvious opportunity for the vehicle to tip over. This type of operation demands constant attention to changes in terrain and the ability to anticipate and avoid possible hazards.

This ability can only be developed through careful study of the points noted in this section and a slow, planned effort on the operator's part to become proficient.

The most effective guard against hazards while operating on slopes, especially during downhill operation, is to keep vehicle speed very low. The Trackster's unique control system allows the vehicle to be driven under full control at the very slowest of speeds. This feature gives the operator the ability to literally "creep" the machine if necessary.



**SAFETY WARNING: WHEN OPERATING ON SLOPES VEHICLE SPEED SHOULD BE KEPT VERY SLOW AND THE OPERATOR SHOULD BE EXTREMELY ALERT FOR CHANGES IN TERRAIN.**

In an effort to determine the exact tip points of the Trackster, tests were conducted to determine the STATIC tip-over points of Tracksters with two passengers in the seat.

A Trackster was placed on a tilt table and tilted forward, backward and sideways until the tip-over point was reached.

The results of this test are shown below.

Keep in mind these are STATIC tip points. This DOES NOT mean that the Trackster can be operated at these angles — it cannot!

Any movement of a Trackster on these slopes can be expected to tip it over.

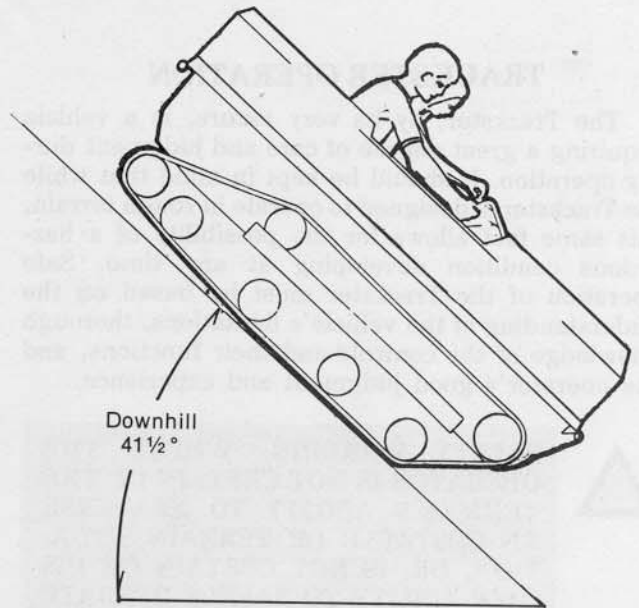
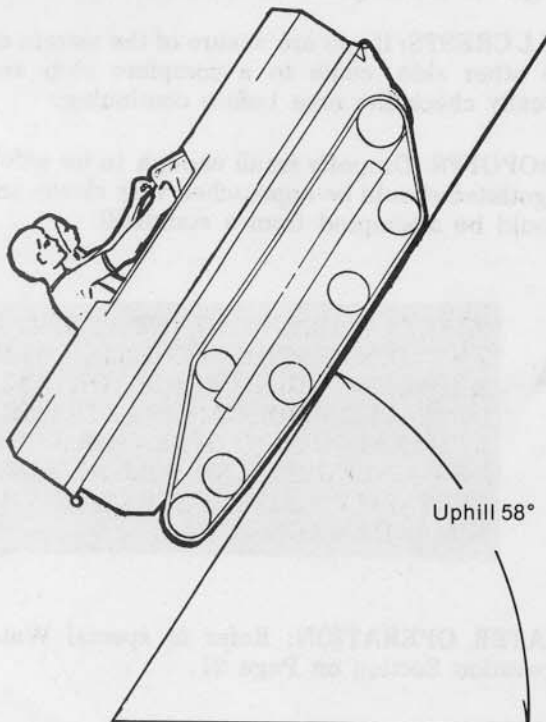

**SAFETY WARNING: DUE TO THE DIFFERENCE BETWEEN UPHILL AND DOWNHILL TIP POINTS AND TRACKED VEHICLE CHARACTERISTICS, THE VEHICLE CANNOT ALWAYS SAFELY DESCEND A SLOPE ALONG THE SAME LINE OF TRAVEL USED TO DRIVE UP.**

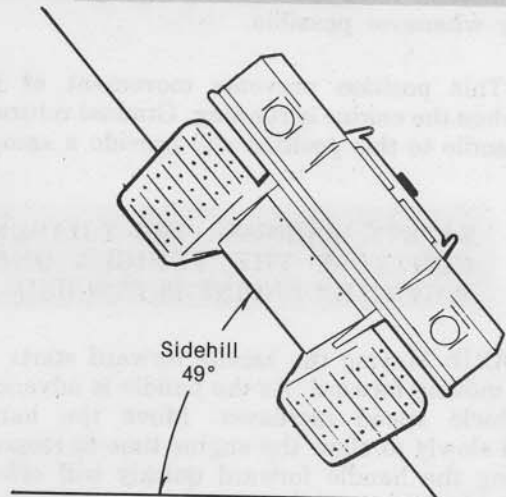

**SAFETY WARNING: THESE TESTS WERE MADE UNDER LABORATORY CONDITIONS. THE FIGURES SHOWN ABOVE ARE NOT THE OPERATING LIMITATIONS. ACTUAL OPERATING LIMITATIONS ARE CONSIDERABLY LESS. THE EFFECT OF INERTIA AND MOMENTUM ON THE VEHICLE IS ALSO AN IMPORTANT FACTOR.**

In addition to this, another set of tests was conducted to determine the effect of various accessories on Trackster stability.



A particular accessory was installed and the machine was tilted forward, backward and sideways until the tip-over points were reached.

The results of these tests are shown below:

	Uphill	Downhill	Sidehill
Cloth Cab . . . . .	— 3½°	— 3°	— 4°
Perry Roll Bar . . . . .	— 6°	— 5°	— 5°
Severin Canopy . . . . .	— 6°	— 7½°	— 7°
Snowplow Lift . . . . .	0°	— 4½°	— 3½°
Micro-Gen Sprayer . . . . .	— 12°	— 3½°	— 11°

**COMMENT:** If the Trackster is equipped with more than one accessory, the stability factors accumulate. For instance, a Trackster with a cloth cab and a Perry roll bar is approximately 8° less stable downhill than the standard Trackster. Keep in mind that the above figures are STATIC tip points.

The design specifications for the Trackster require that the vehicle have enough tractive power to climb an ideal 45° slope. It can be very dangerous to actually use the machine on real-life hills or slopes of much less than 45° of slope. Obviously, the steeper the slope, the greater hazard of tipping over.

In some ways this can be compared to using an automobile for which the specifications show a maximum speed capability of 130 miles per hour. The car may be capable of that speed in the hands of an expert test driver on an ideal track—but it would be extremely dangerous for the average driver to use anything approaching that maximum speed capability on a real-life road.

Just as the fast car has more speed capability than can safely be used under real road conditions, your Trackster has more climbing capability than can safely be used in real terrain conditions. For instance, the Trackster can climb a steeper hill than it can safely descend. A skilled operator may take advantage of the Trackster's capability to climb a steep slope, knowing that he must descend by a more gentle route. The less cautious or less experienced operator, on the other hand, having climbed the hill might simply turn the vehicle around

and attempt to descend by the same path—possibly with disastrous results.

In our example of the fast car, it is possible to provide a reasonable level of safety for the driver and others by setting a speed limit on the public roads—a speed far below the maximum speed of which the car is capable.

A similar approach to safe Trackster operation would caution owners against using their vehicles on slopes steeper than some arbitrary limit (such as 20° or 25°) well below the maximum slope which the Trackster is capable of climbing or descending under ideal conditions.

This approach is good in principle—but in practice it is impossible to rationally set a slope steepness limit which guarantees safe operation regardless of how the vehicle is used. Such a limit could instill a false sense of security because, as with any off-the-road vehicle, the Trackster is routinely exposed to a far wider range of operating hazards than is an automobile and many variables enter into any determination of what is safe usage.

Vehicle stability on a hill, for example, is determined not only by the general slope of the hill but also by terrain conditions (rocks, ditches, logs, dropoffs, etc.)—and by the nature of the hill surface (gravel, sand, grass, snow, rock, etc.), the payload which the vehicle is carrying, the manner in which the payload is distributed within the vehicle, attachments and accessories which have been added to the vehicle, and so forth.

Similarly, driving technique and its effect on vehicle stability enters into any determination of what constitutes a safe slope. Excessive speed, sudden braking, choice of path—all can be critical.

The following illustrations depict some situations in which the Trackster can be expected to tip over. Variations in speed, loading, terrain and vehicle condition must all be analyzed to determine whether or not a specific obstacle can be traversed. If in doubt, do not attempt.



**SAFETY WARNING: ON STEEPER SLOPES SMALLER OBSTACLES WILL CAUSE THE TRACKSTER TO TIP OVER.**

## ADDITION OF ROLL BARS

While rollover protective structures (roll bars/cages) may provide some passenger protection if a rollover should occur, it must be remembered that any such structure with its bulk above the vehicle's original center of gravity will detract from the Trackster's stability. (See stability effects of accessories on a Trackster, above).



**SAFETY WARNING: IN RARE INSTANCES A ROLL BAR/CAGE ASSEMBLY COULD ALLOW A TRACKSTER TO CONTINUE ROLLING DOWN A STEEP SLOPE IF IT TIPS OVER. THIS IS DUE TO THE FACT THAT MANY ROLLOVER PROTECTIVE STRUCTURES NEGATE THE EFFECT OF THE VEHICLE'S FLAT SURFACES WHICH TEND TO PROHIBIT CONTINUED ROLLING. THIS INFORMATION SHOULD BE CONSIDERED IF YOU PLAN TO ADD SUCH AN ACCESSORY.**

# UPHILL OPERATION

It is common to see a situation where natural erosion has caused the very top of a bank or hill to rise sharply. Always check for this condition before attempting to climb any such type of terrain. The Trackster could climb up to a point at which it falls over backward.

It is also very important to check for this terrain condition before going down over the edge of a bank or dropoff.

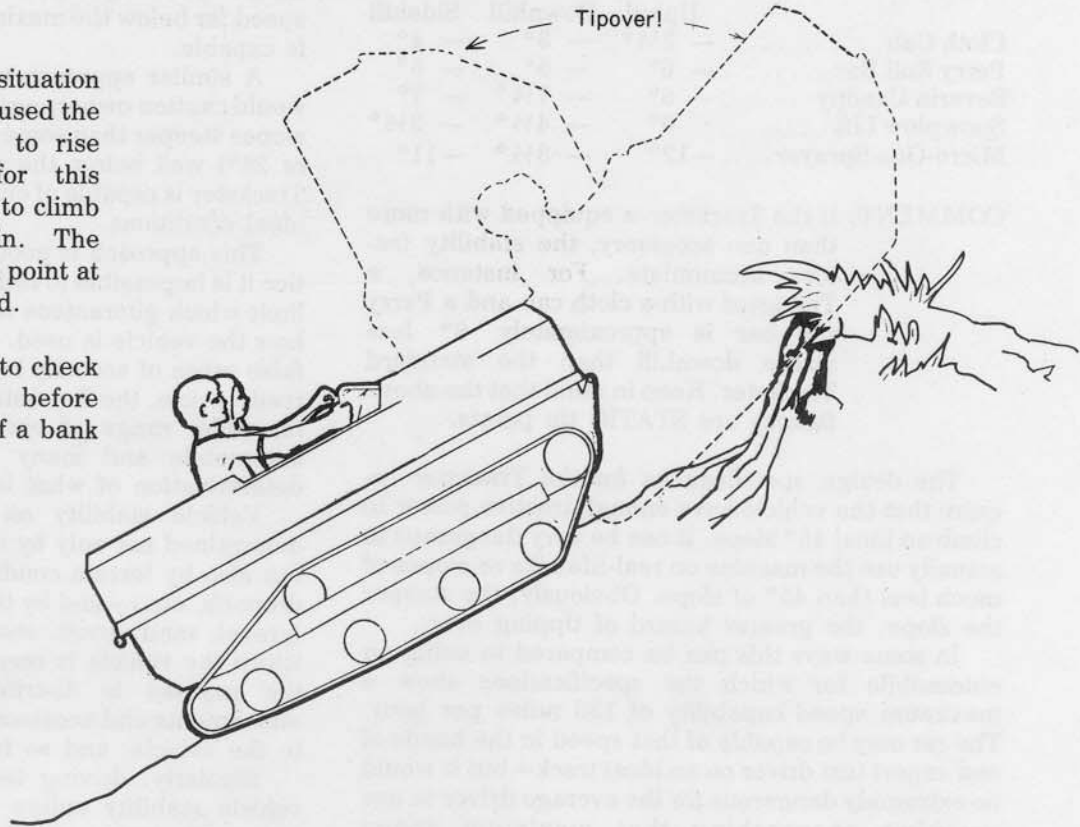

The same situation can occur where an imbedded object is pulled from the ground. The vehicle track may "grab" a rock or log. As the object emerges from the ground, rolling under the track, the vehicle could climb to the point at which it falls over backward.

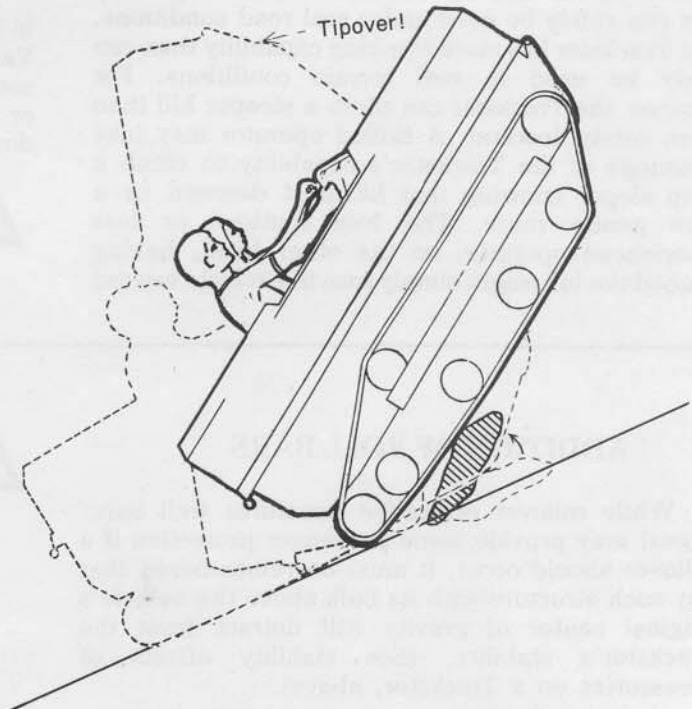

# DOWNHILL OPERATION

## SUDDEN STOPS

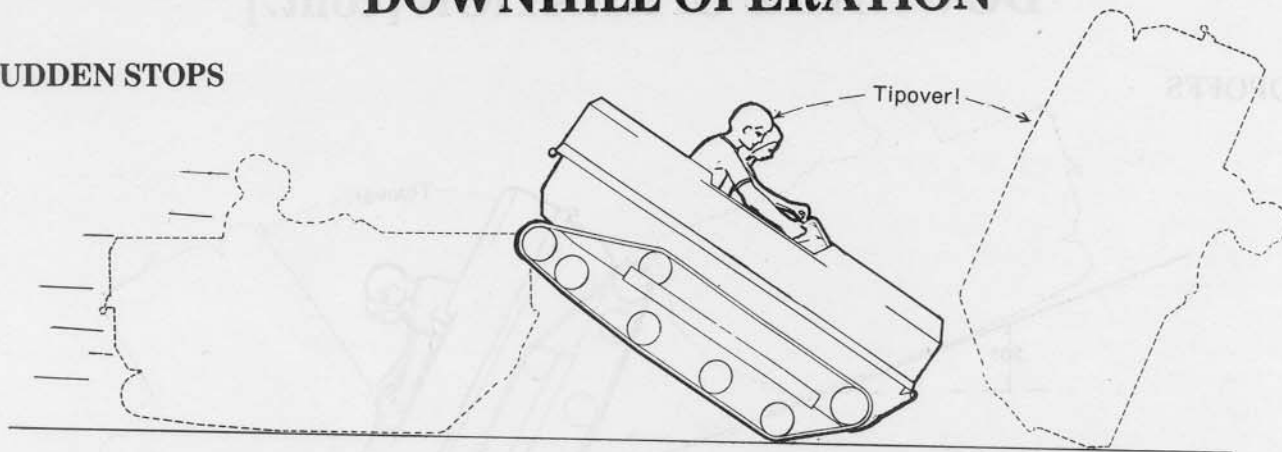

If a Trackster is driven down a slope and the tracks are stopped suddenly, the vehicle's exceptional traction may cause it to tip over forward.



**SAFETY WARNING: IF VEHICLE MOTION IS ABRUPTLY DECREASED OR STOPPED, [EXAMPLE: T-HANDLE MOVED TO STOP POSITION, ENGINE OR HYDRAULIC SYSTEM FAILURE] THE TRACKSTER CAN TIP OVER FORWARD. THIS POSSIBILITY BECOMES GREATER AS VEHICLE SPEED AND/OR DOWNSLOPE INCREASES.**

## CROSSING OVER AN OBJECT

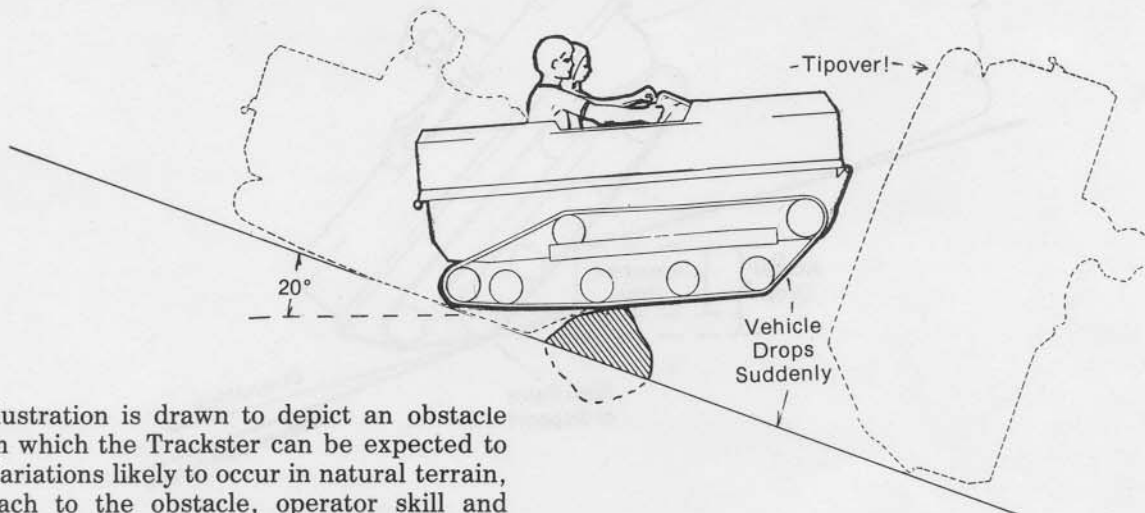

This illustration is drawn to depict an obstacle situation in which the Trackster can be expected to tip over. Variations likely to occur in natural terrain, the approach to the obstacle, operator skill and loading of the Trackster may reduce the size of obstacle or steepness of the slope, which could cause tipover.



**SAFETY WARNING: IF THE VEHICLE CENTER OF GRAVITY PASSES THE POINT OF SUPPORT, THE TRACKSTER WILL BEGIN TO TIP. UNLESS THE TERRAIN ON THE DOWNSIDE OF THE OBJECT PROVIDES A NEW POINT OF SUPPORT, FAR ENOUGH AHEAD OF THE VEHICLE CENTER OF GRAVITY TO NEGATE THE EFFECT OF INERTIA, THE TRACKSTER WILL TIP OVER FORWARD.**



**SAFETY WARNING: ON STEEPER SLOPES, SMALLER OBSTACLES WILL CAUSE THE TRACKSTER TO TIP OVER.**



**SAFETY WARNING: OBSTACLES, SOME OF WHICH MIGHT BE DRIVEN OVER SAFELY WHILE ON LEVEL TERRAIN, CAN CAUSE A HAZARD WHILE OPERATING ON SLOPES.**



# DOWNHILL OPERATION [cont.]

## DROPOFFS

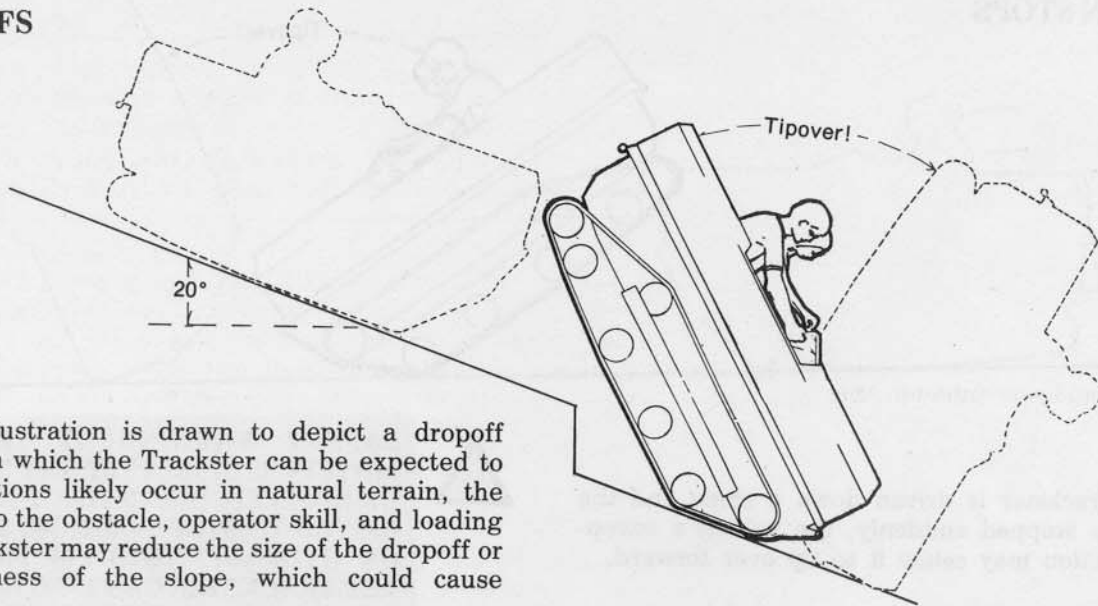

This illustration is drawn to depict a dropoff situation in which the Trackster can be expected to flip. Variations likely occur in natural terrain, the approach to the obstacle, operator skill, and loading of the Trackster may reduce the size of the dropoff or the steepness of the slope, which could cause tipover.

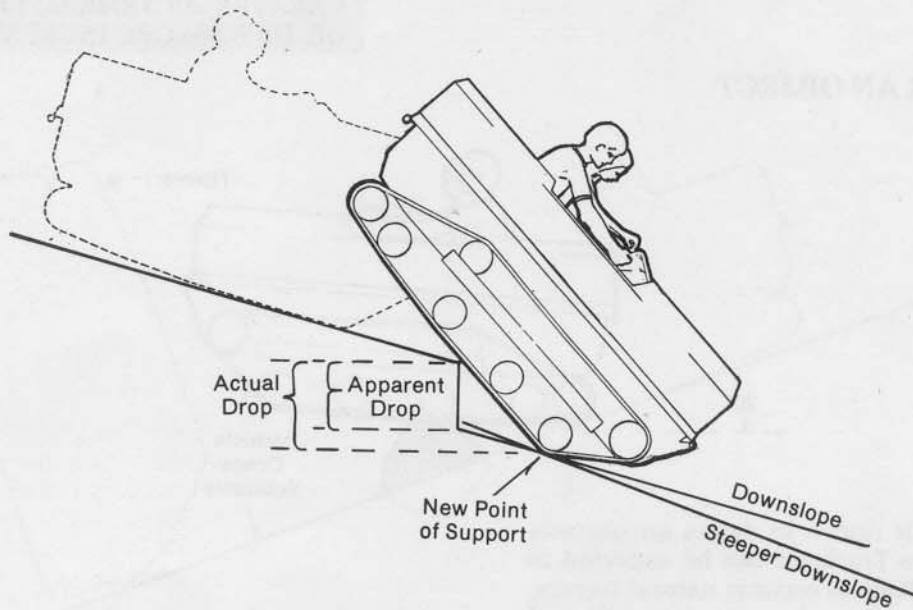

An important variable in determining if a given obstacle will cause a Trackster to tip over is the vertical distance between the last point of contact and the new point of support. Note that the new point of support can be on level ground, a downhill slope, or a steeper downhill slope. The apparent size of the obstacle or dropoff is not the same as the drop it causes. Among the many other variables are the steepness of the slopes, size of the obstacle causing the drop, the shape of the last point of support, the load in the Trackster, initial speed, tightness of the track, traction, symmetry of the obstacle to the Trackster, and operator skill and judgment.



**SAFETY WARNING: THE TRACKSTER MUST BE OPERATED WITH GREAT CARE AT ALL TIMES AND ON ANY SLOPE. SLOPES STEEPER THAN 20° SHOULD BE REGARDED AS ULTRA-HAZARDOUS AND APPROACHED WITH EXTREME CAUTION. EVEN ON SLOPES OF LESS THAN 20°, THE TRACKSTER CAN BE TIPPED OVER BY A SUDDEN STOP, EXCESSIVE SPEED, UNEVEN TERRAIN, OR OTHER SPECIAL CONDITIONS OR COMBINATIONS OF SUCH CONDITIONS.**

## SIDEHILL OPERATION

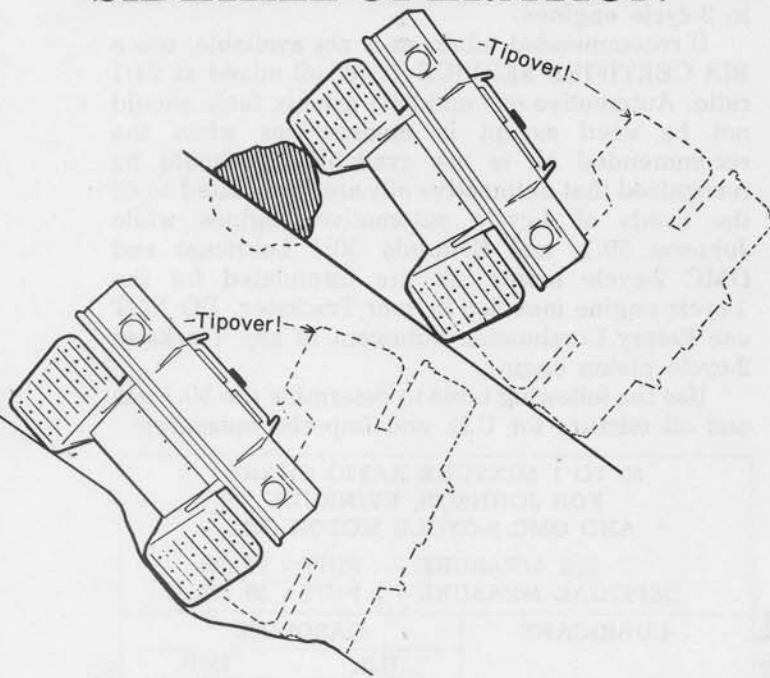

The illustrations show how driving over an obstacle with the uphill track or into a hole with the downhill track will cause the vehicle to tip over sideways.

A slippery surface, like snow, ice, frozen sand, and loose gravel can also be dangerous. It is possible to slide into a tree or rock or to slide off the edge of a cliff.



**SAFETY WARNING: REGARD ALL OPERATIONS ON SLOPING TERRAIN AS HAZARDOUS.**

## PARKING THE VEHICLE

When the Trackster is parked on a sufficient slope, failure to engage the parking brake—or failure of the parking brake to function properly—can result in the vehicle rolling down the slope, out of control. A wet condition, or a buildup of mud, snow or other foreign matter on the track or brake pad can reduce original equipment parking brake efficiency or render the original equipment parking brake useless, as can maladjustment of the brake actuating linkage, freezing due to corrosion or cold, etc.

In the interest of greater parking safety, we have developed a new device — called a “sprocket lock”. Actuated by the drop in oil pressure in the hydrostatic transmission, the sprocket lock engages automatically with no action by the operator whenever the Trackster engine stops. The device causes a steel pin to lock the track drive sprocket against rotation and so prevent track motion. Starting the engine causes the sprocket lock to disengage automatically. Since it is not a friction brake, it is unaffected by snow, ice, mud, etc. on the track.



**SAFETY WARNING: DO NOT OPERATE TRACKSTER ON SLOPES UNLESS EQUIPPED WITH SPROCKET LOCK.**

**SPECIAL NOTE: IF YOUR TRACKSTER IS NOT EQUIPPED WITH A SPROCKET LOCK, ONE WILL BE INSTALLED, AT NO COST TO YOU FOR MATERIAL OR LABOR, BY ANY AUTHORIZED TRACKSTER DEALER.**

If the vehicle is parked on a slope, pressure on the sprocket lock pin may prevent its disengagement when the engine is started. If this occurs, simply move the machine slightly upgrade to allow the drive sprocket teeth to back away from the pin. It will then release.

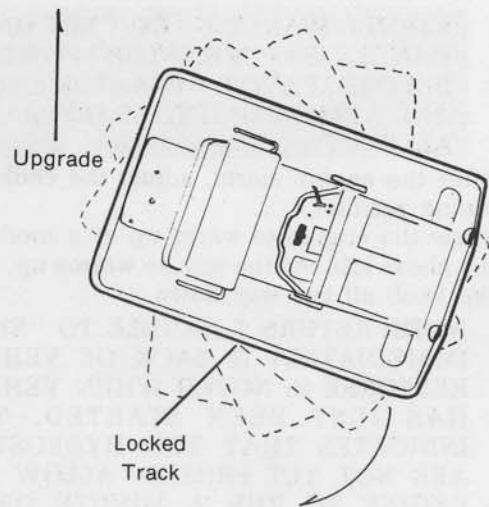

If the engine is to be shut off while on a slope, the Trackster should be turned to point across, not up or down, the slope, with the right (sprocket lock side) track on the uphill side. If the right track is not on the uphill side, the left track is free to turn after the hydraulic pressure drops, allowing the vehicle to move as illustrated above.

## OPERATING SAFETY PRECAUTIONS

1. Allow passengers only in seats provided. (Maximum of 4 people)
2. Keep hands and feet inside vehicle.
3. Use handholds provided.
4. Never attempt to operate the vehicle from anywhere other than the driver's seat.
5. Avoid unnecessary quick stops. Always return the T-Handle to the stop position slowly with light pressure.
6. Avoid quick turns which may dislodge unsuspecting passengers.
7. Shut off engine when leaving vehicle.
8. Park sideways on slopes.

## STARTING THE ENGINE

1. Place T-handle in STOP position.
2. Pull up choke knob.
3. Press primer if required.
4. Advance engine speed control lever approximately halfway.

5. Turn ignition switch to start position until engine starts, then release the key and it will return to the "on" position.

6. If the engine does not start immediately, prime and repeat from Step 5. The number of times the primer must be pressed will depend on the operator becoming familiar with starting a cold or warm engine. Do not over-prime. Priming delivers liquid fuel to the crankcase, by-passing the carburetor.

7. If the electric starter should not function, the rewind manual starter can be used. Grasp the starter handle firmly, pull slowly until the starter engages, then pull to start the engine.



**SAFETY WARNING: BE CERTAIN T-HANDLE IS IN THE "STOP" POSITION BEFORE LEAVING OPERATOR'S SEAT AND ATTEMPTING TO START MANUALLY.**

8. After the engine starts, adjust the choke for best running results.

9. Allow the engine to warm up at a moderate speed just above idle. As the engine warms up, push the choke knob all the way down.



**NOTE: RETURN T-HANDLE TO "STOP" IMMEDIATELY IF LACK OF VEHICLE RESPONSE IS NOTED WHEN VEHICLE HAS JUST BEEN STARTED. THIS INDICATES THAT THE HYDROSTATS ARE NOT YET PRIMED. ALLOW THE ENGINE TO RUN A MINUTE OR SO MORE BEFORE ENGAGING T-HANDLE AGAIN. IF THIS IS NOT DONE, HYDROSTAT DAMAGE COULD RESULT.**

## COLD WEATHER STARTING

All 1975 and later Tracksters are equipped with a transmission fluid valve, located below the left hydrostat, to aid in priming the hydrostats in cold weather. When the outside temperature drops below 32° Fahrenheit, this valve should be opened before starting engine.



**NOTE: THE VALVE SHOULD BE CLOSED WHEN THE OUTSIDE TEMPERATURE IS ABOVE 45° OR IF THE OIL TEMPERATURE LIGHT COMES ON.**

## FUEL RECOMMENDATIONS



**NOTE: THE TRACKSTER IS EQUIPPED WITH A TWO-CYCLE ENGINE. OIL MUST BE MIXED WITH THE GASOLINE.**

The correct gas/oil mixture ration is 50 parts of a good grade, regular leaded gasoline to one part Johnson 50:1, Evinrude 50:1 Lubricant, or in Canada OMC 2-cycle motor oil.

In some gasolines the amount of lead has been

replaced with phosphorus. Do not use this type of gasoline, since phosphorus is detrimental when used in 2-cycle engines.

If recommended lubricant is not available, use a BIA CERTIFIED SERVICE TC-W oil mixed at 24:1 ratio. Automotive oils and 24:1 premix fuels should not be used except in emergencies when the recommended oil is not available. It should be recognized that automotive oils are formulated to fit the needs of 4-cycle automotive engines while Johnson 50:1, and Evinrude 50:1 Lubricant and OMC 2-cycle motor oils are formulated for the 2-cycle engine installed in your Trackster. DO NOT use Rotary Combustion Lubricant in any Trackster 2-cycle piston engine.

Use the following table to determine the 50:1 gas and oil mixture for U.S. and Imperial measures:

50 TO 1 MIXTURE RATIO CHART FOR JOHNSON, EVINRUDE AND OMC 2-CYCLE MOTOR OIL		
U.S. MEASURE - 1 PINT - 16 OZ. IMPERIAL MEASURE - 1 PINT - 20 OZ.		
LUBRICANT	GASOLINE	
	U.S. MEASURE	IMP. MEASURE
½ U.S. pint ..Mix with	3 U.S. gal.	2.4 Imp. gal.
½ Imp. pint ..Mix with	3.7 U.S. gal.	3 Imp. gal.
1 U.S. pint ....Mix with	6 U.S. gal.	4.8 Imp. gal.
1 Imp. pint ....Mix with	7.5 U.S. gal.	6 Imp. gal.

## Mixing Fuel

Use only a good grade of regular gasoline. Higher octane fuels may be used but generally do not offer any advantages.



**SAFETY WARNING: GASOLINE IS EXTREMELY FLAMMABLE AND HIGHLY EXPLOSIVE UNDER CERTAIN CONDITIONS. ALWAYS STOP ENGINE, AND DO NOT SMOKE OR ALLOW OPEN FLAMES OR SPARK WHEN MIXING FUEL OR REFUELING.**



**NOTE: NON-LEADED GASOLINE IS NOT APPROVED FOR USE IN THE TRACKSTER.**

To prepare the Trackster fuel properly, pour into a SEPARATE clean container, half the amount of regular gasoline required and add all the required oil. Thoroughly shake this partial mixture. Next, add the balance of the gasoline necessary to bring the mixture to the required ratio. Again, thoroughly shake the mixture. A clean funnel equipped with a fine screen should be used when pouring the fuel mixture into the vehicle tank.

When it is necessary to mix gas and oil at temperatures below 32° F., the oil should be prediluted with gasoline to improve its mixability. Predilute the oil by adding one part gasoline to one part oil. When doing this, the oil temperature should be above 32° F. DO NOT use kerosene or fuel oils for prediluting oil.



**SAFETY WARNING: A LARGE FUNNEL MAY BE NEEDED TO FUEL THE TRACKSTER. WIPE UP SPILLS TO REDUCE HAZARD OF FIRE OR EXPLOSION.**



# MAINTENANCE

## ENGINE

### Lubrication

Both engine performance and lubrication depend on maintaining the correct ratio between gasoline and oil in the fuel mixture. The use of too little oil leads to premature wear. A fuel mixture richer in oil than recommended is not only wasteful but will contribute to faulty performance and to excessive carbon accumulation in the cylinders and on the spark plugs. Frequent spark plug replacement can often be traced to an excess of oil in the fuel mixture. Instructions for mixing fuel are given in this manual and should be followed exactly.

### Tune-up

In the normal operation of an engine, the operator may not be fully aware of the decrease in performance which takes place slowly over a long period of time. Economical, trouble-free operation can best be assured if a complete tune-up is performed at least once each year.

Components which affect power and performance can be divided into three groups which are:

1. Items affecting compression
2. Items affecting ignition
3. Items affecting carburetion

A tune-up should cover these groups in the order given. Correction of items affecting carburetion should not be attempted until all items affecting compression and ignition have been corrected satisfactorily.

A complete tune-up should include the following operations. Procedures for these operations appear in this manual under the appropriate heading.

1. Compression check.
2. Clean and gap or replace spark plugs.
3. Adjust or replace breaker points.
4. Check governor for proper operation and oil level.
5. Adjust carburetor.
6. Check air cleaner element.
7. Inspect entire fuel system for leaks, install new fuel filter and clean fuel screens in fuel tank and pump.
8. Inspect starter and governor belts.
9. Be sure the correct fuel mixture is being used.

### Compression

Cylinder compression can be checked by using an automotive-type compression gauge as follows: Remove both spark plugs, be sure the choke knob is pushed in, set the engine speed lever at maximum and turn the engine over quickly three or four times with the manual starter. The compression in each cylinder should be 100 pounds minimum. If the compression is below this figure, the engine cannot be tuned for peak performance and further service is needed.

### Ignition

The Trackster is equipped with a CD (Capacitor-Discharge) ignition system which provides longer breaker point and spark plug life, easier engine starting and smoother engine performance.

Battery voltage is fed into the Pulse-Amplifier which "steps-up" the voltage and stores it. The breaker points trigger the release of the voltage which then goes instantaneously through the ignition coils and to the spark plugs. Current across the breaker points is low and voltage across the spark plugs is high.

Service of the CD system should be performed by your Trackster dealer who has the necessary equipment and knowledge.

### Spark Plugs

Spark plugs having the proper heat range are very important for peak performance of the engine. Use only Champion J2J or equivalent. DO NOT clean spark plugs on abrasive blasting machines. Blasting tends to pack the abrasive between the insulator and the metal shell of the plug. Any abrasive left in the plug may pass through the engine causing piston or cylinder wall wear.

### Breaker Points

1. Remove air intake chamber.
2. Remove the manual starter from the fan housing.
3. Remove the governor bracket and governor. Mark the hole the throttle spring is hooked in.
4. Remove the manual starter ratchet adapter from the flywheel.
5. Loosen the belt tension and remove the starter belt.
6. Remove the flywheel nut.
7. The flywheel can now be removed by using a flywheel puller or a 5/8-18 knock-off (Part No. 809316). Be sure the knock-off is screwed onto the crankshaft as far as it will go, apply light pressure to the back of the flywheel and hit the knock-off a sharp blow with a metal hammer.

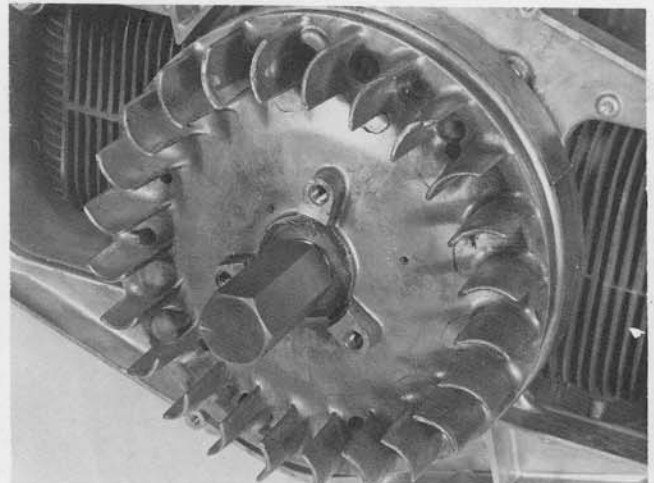

Under normal running conditions, breaker points will appear slightly rough and gray in color. Abnormal points will appear excessively pitted, may have a considerable amount of material transferred from one contact surface to another, and will be generally blue in color.

The points may be cleaned by saturating a clean strip of cotton material in alcohol and working it up and down between the points. Finish with a clean piece of paper or card to remove any residue. If the points cannot be cleaned satisfactorily by this method, replace them.

Remove the breaker points by disconnecting the wire lead, breaker retaining screw and clip.

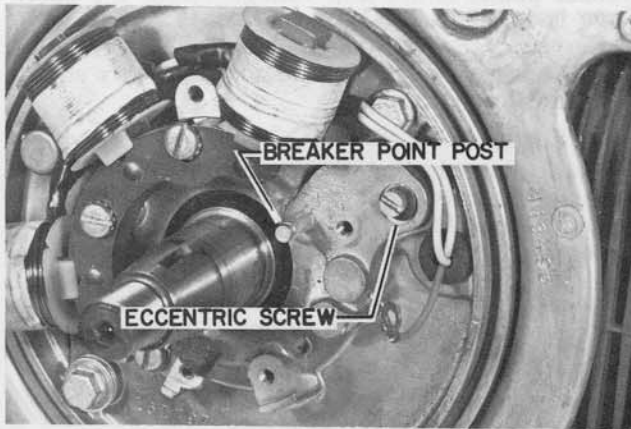

#### Installing New Points

1. Clean the breaker post thoroughly.
2. Turn the eccentric adjusting screw into the plate until it bottoms.
3. Install breaker assembly over breaker post.
4. Replace breaker retaining screw and clip. Connect the wire lead to the breaker point screw terminal.
5. Install new oiler wick.
6. Install the breaker cam and key on the crankshaft, position the breaker arm on the high lobe of the cam and adjust the points to a .020-.022 gap with a feeler gauge. **INSURE POINT CONTACTS ARE FREE OF ALL GREASE AND FOREIGN MATERIAL.**

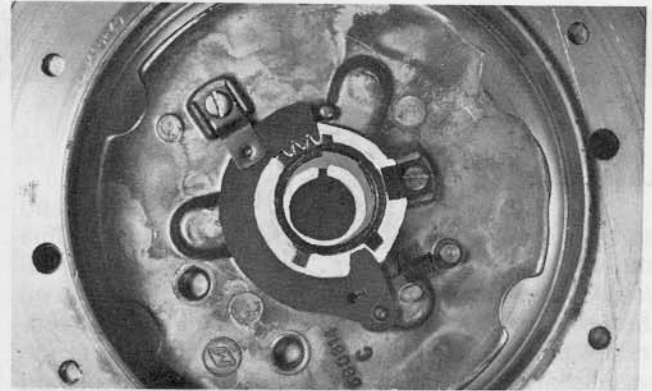
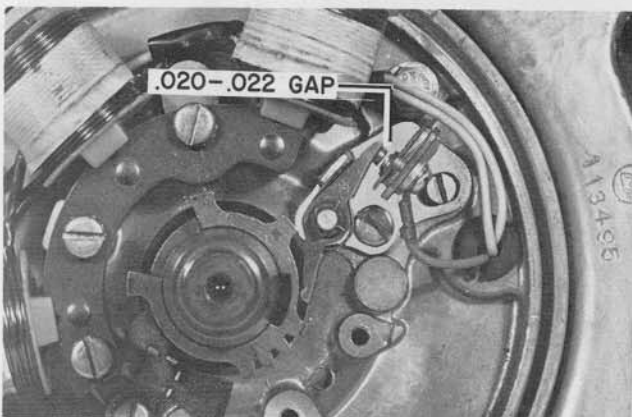

25 H.P.

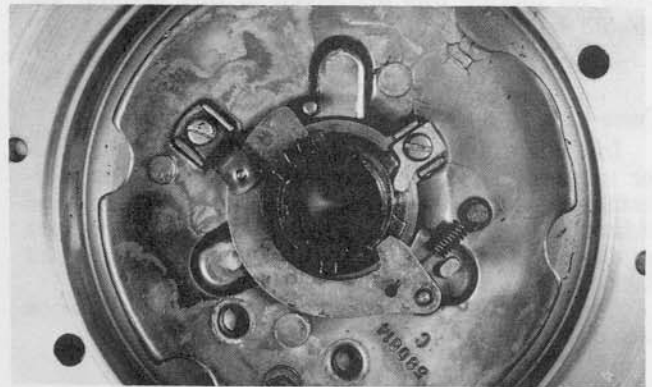

29 H.P.

7. Remove the cam from the crankshaft and position it in the flywheel as shown. Edge of keyway in cam must be aligned with edge of keyway in flywheel when viewed from the outside of the flywheel as shown.

8. Rotate the crankshaft so the keyway is 180° opposite the breaker point pivot pin.

9. Place flywheel and cam assembly on crankshaft. **BE SURE** the cam has not slipped out of position. When the flywheel is properly seated, the outer edge will be approximately 1/32" above the shoulder on the crankshaft, **DO NOT** use force. The breaker cam can be broken by improper installation. If it is impossible to position the flywheel properly, remove it and repeat the above procedure.

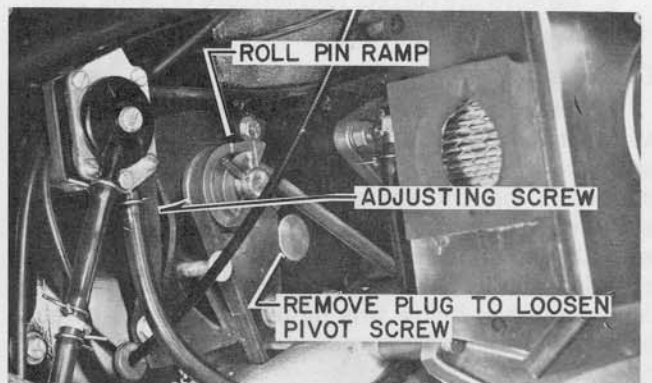

10. Place the flywheel washer and nut on the crankshaft and tighten nut to 40-45 foot pounds.

11. When this procedure is followed, the engine is timed correctly and no further adjustment is necessary.

12. Reinstall starter belt, manual starter ratchet and governor and bracket. Adjust the starter belt to be snug when the movable pulley is halfway up the roll pin ramp. Adjust the governor belt to provide 1/2" deflection with slight pressure of the belt midway between the pulleys. Hook the governor spring back into the original hole on the governor lever.

13. Check governor for proper adjustment.

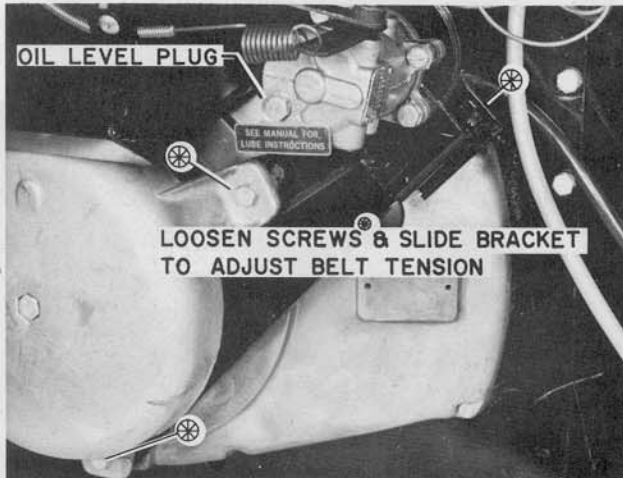

### Governor

Check the governor oil level at least every 90 days. Add 10W30 engine oil as required to bring oil to the filler plug level as shown. DO NOT OVER-FILL.

### Adjustment

Proper governor adjustment will provide a maximum engine RPM of 5600 - 5900. Place the T-handle in the stop position, start the engine, advance the Engine Speed Control to maximum and check the engine RPM with a tachometer.

If the engine RPM is too high, loosen the throttle wire clamp on the engine speed lever and move the

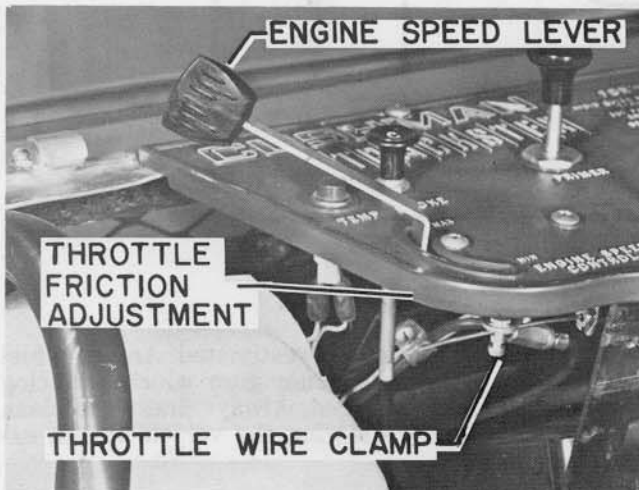

wire to decrease the tension on the governor spring.

If the engine RPM is too low, adjust the wire to increase the tension on the spring. Be sure the wire housing is not obstructing the wire travel on the spring end.

Engine speed lever should be adjusted to allow automatic return to "MIN." position when lever is released.

Adjust the carburetor high speed needle until engine runs smoothly. (7/8 to 1 1/4 turns open.)

When the engine will not maintain a constant RPM or is "hunting" continually, the governor may

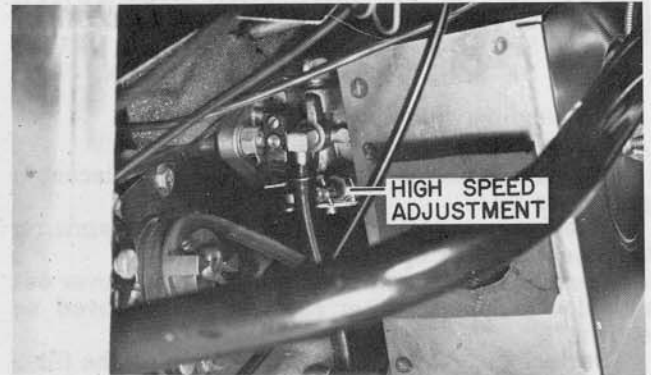

be adjusted too sensitive or the carburetor high speed needle is adjusted too lean. Move the governor spring hook to the next hole in the arm away from the governor until the engine responds satisfactorily. Readjust the throttle wire and spring for top RPM of 5600-5900.

A slight variation in RPM, or "hunting" at maximum engine speed with the T-handle in the STOP position is normal.

**NOTE: "LEANING OUT" OF THE HIGH SPEED NEEDLE VALVE WILL RESULT IN SERIOUS DAMAGE TO THE ENGINE. NEVER SET THE HIGH SPEED NEEDLE LESS THAN 7/8 TURN OPEN.**

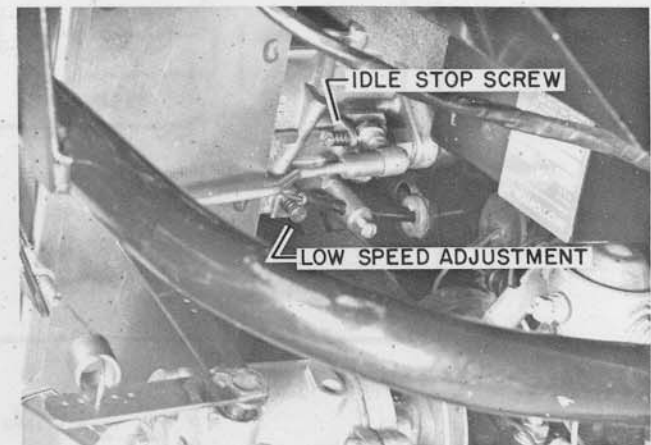

### Carburetor Adjustment

Carburetor adjustments should always be made with the engine at the normal operating temperature.



1. Set the engine control on minimum and adjust the idle stop screw to maintain 1000-1100 engine RPM.

2. Adjust the low speed needle to provide the fastest and smoothest engine idle. Readjust the idle stop screw for 1000-1100 RPM.

3. Move the Engine Speed Lever to maximum, turn the high speed needle counterclockwise (out) permitting the engine to run rich to where it begins to 4-cycle (load-up). Turn the needle back clockwise (in) gradually until the engine runs smooth. Be sure to give the engine time to respond.

**NOTE: TO MAINTAIN ADEQUATE CYLINDER LUBRICATION, THE HIGH SPEED NEEDLE VALVE SHOULD NEVER BE LESS THAN 7/8 TURN OPEN.**

4. Readjust idle speed to 1000-1100.

#### Air Cleaner

The Trackster is equipped with a replaceable paper air filter.

The frequency of air cleaner service depends on the conditions of operation.

Remove the wing nut and pull the filter cover out and down. The air filter can now be removed as shown.

Surface dirt may be removed by tapping the filter lightly. The condition of the filter can be determined by holding it over a light bulb. If no light can be seen, the filter is clogged. Pinholes of bright light indicate holes which will allow dirt to enter the engine. Replace the filter if either condition exists. A filter saturated with oil should also be replaced.

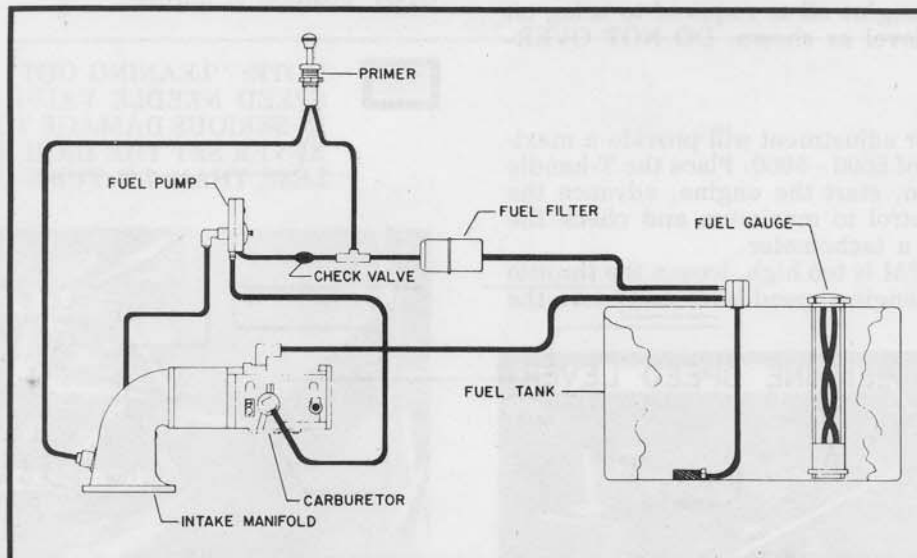
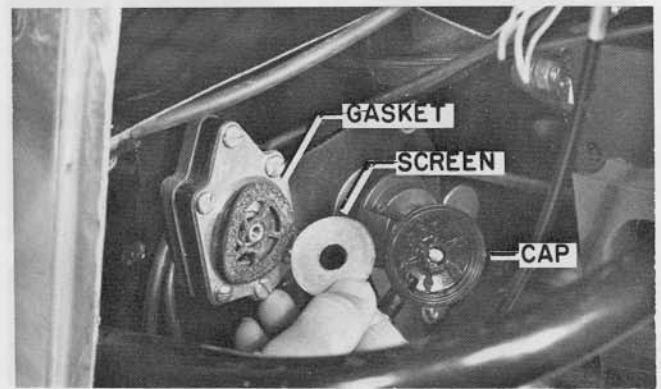
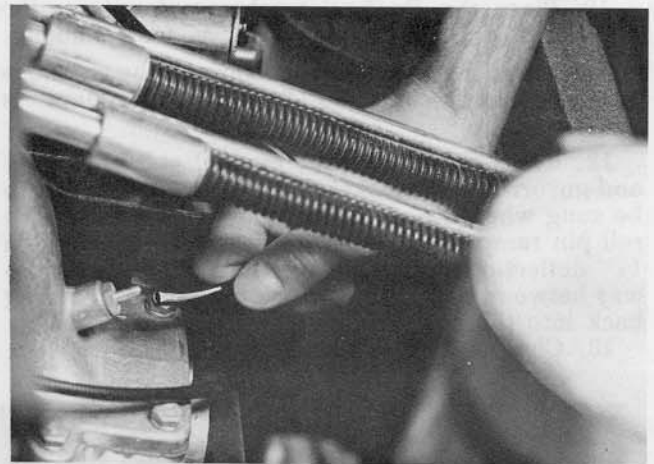

### FUEL SYSTEM

The complete fuel system consists of the fuel tank, fuel filter, fuel pump, primer, carburetor and all connecting hoses.

#### Fuel Tank

The importance of using a fresh, clean fuel

mixture should not be underestimated. An aging fuel mixture promotes petroleum gum which will clog screens and fuel passages. Always drain and clean the fuel tank before storing the vehicle for an extended period.



## Transmission



**NOTE: DO NOT RUN THE ENGINE IF THE TRANSMISSION FLUID LEVEL IS LOW OR THE FLUID HAS BECOME CONTAMINATED.**

The transmission hydraulic system is sealed so contamination can only enter through the dipstick tube. Always make sure it is secure.

Check transmission fluid level before starting engine previous to each day's use. Make sure fluid level is between the "full" and "add" marks on the dipstick.

A fluid change is required **ONLY** if contamination has entered the system. **ANY** other service to the hydraulic system **MUST** be performed by qualified persons.



**NOTE: A LOW FLUID LEVEL INDICATES A FLUID LEAK WHILE AN OVERFULL SITUATION IS EVIDENCE OF AN AIR LEAK. IN BOTH CASES SERVICE IS NEEDED.**

## T-handle

The T-handle adjustment is obtained by changing the length of the control rods. Raise the vehicle to allow both tracks to clear the floor. Loosen the lock nuts as shown and turn the rods until both tracks are stopped when the T-handle is in the STOP position. Note: Adjustment should be made with transmission oil warm.



**NOTE: CHECK BALL JOINT NUT FOR TIGHTNESS.**



**SAFETY WARNING: INSPECT CONTROL ASSEMBLY AND LOCKNUTS FREQUENTLY. MISSING OR DAMAGED CONTROL ASSEMBLY PARTS COULD RESULT IN LOSS OF VEHICLE CONTROL.**

The T-handle mechanism contains a means for adjusting the stiffness of handle movement. The adjusting is somewhat subjective, but an incorrect adjustment for a given vehicle operator can result in erratic vehicle response which can be hazardous in some terrain situations.

A simple test can be made by pushing the T-handle all the way forward (engine off) and hooking an ordinary "fishing" scale directly under the T-handle crossbar. Pull back smoothly (towards "stop" position), if the scale reads between 6 and 10 lbs. pull, the T-handle is within manufacturing tolerances.

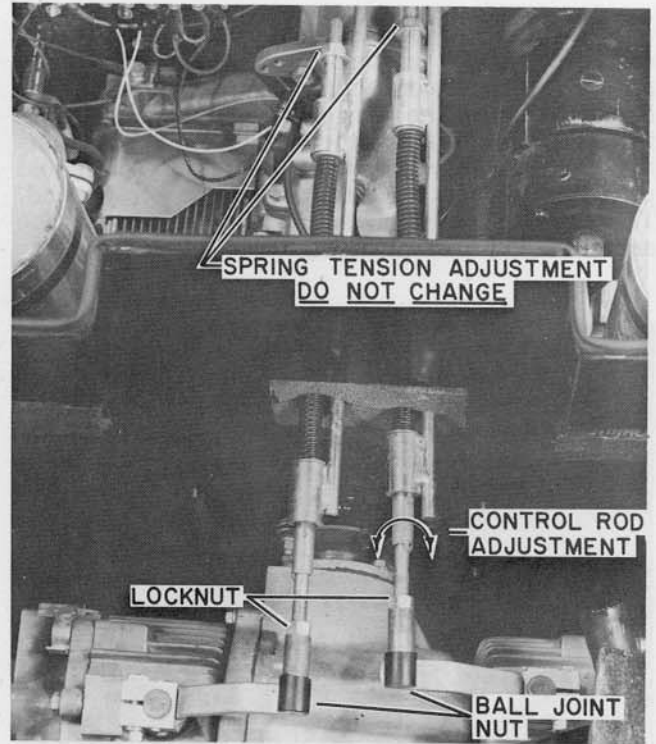

(SHOWN WITH HEAT EXCHANGER REMOVED)



**NOTE: THE SPRING TENSION ON EACH ROD IS PRESET FOR OVERLOAD PROTECTION AND MUST NOT BE CHANGED.**

Adjust by loosening the lock nut, tighten or loosen the adjusting nut as shown and retighten the lock nut.

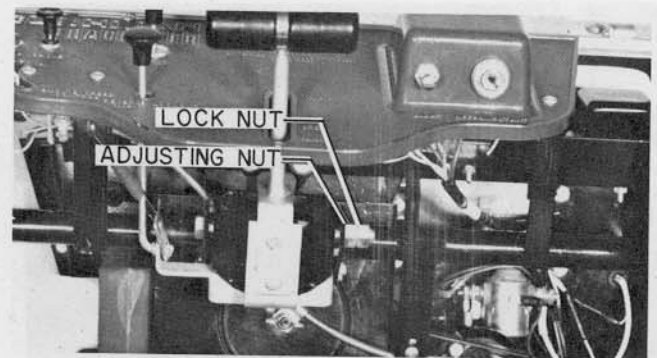

## Track Adjustment

Proper track adjustment will provide a  $\frac{1}{2}$ " sag between the drive sprocket and the upper bogie wheels. This distance can be measured by placing a straight edge on the top surface of the track as shown. Park the vehicle on a flat, level surface before making this measurement.



**NOTE: NEVER ADJUST TRACKS TO LESS THAN  $\frac{1}{2}$ " SAG. OPERATING THE VEHICLE WITH TOO MUCH TENSION ON THE TRACKS WILL CAUSE PREMATURE WEAR ON THE BOGIE WHEEL BEARINGS.**



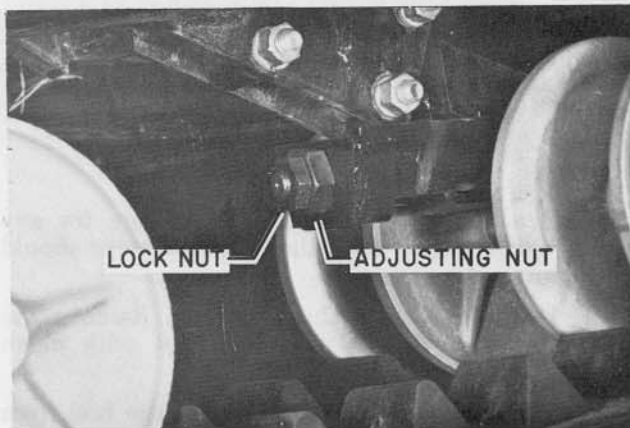
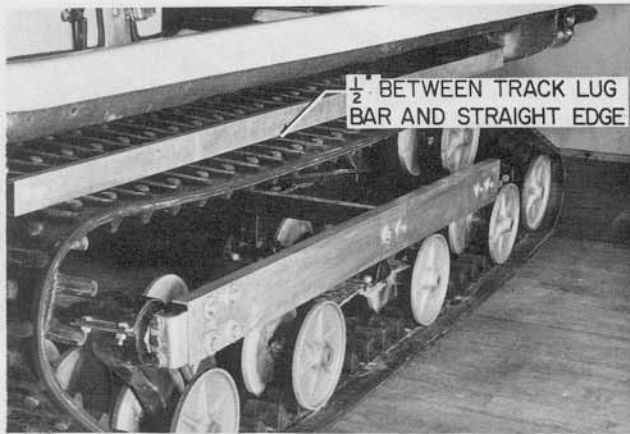

## REPLACING "THROWN" TRACK

In the event that a portion of a track slips off, it will almost always occur at the rear, with the track moving toward the body.

In this instance it is usually possible to "drive" it back into place. Move the vehicle forward slowly and make a gradual turn in the direction of the slipped track. (right track off: right turn, left track off: left turn.) **DO NOT** back up as this will usually cause the front of the track to run off.

### Sprocket Wear

Sprocket wear should be checked by measuring the width of the teeth at a point one inch from the tip. If any tooth on the sprocket is narrower at this point than the minimum widths shown in the illustrations, (above right) a new sprocket should be installed.



**SAFETY WARNING: EXCESSIVE WEAR CAN CAUSE TEETH TO BECOME WEAKENED, RESULTING IN BREAKING OR BENDING. THIS COULD RENDER THE SPROCKET LOCK INEFFECTIVE IF SUDDEN HYDRAULIC PRESSURE LOSS IS ENCOUNTERED.**

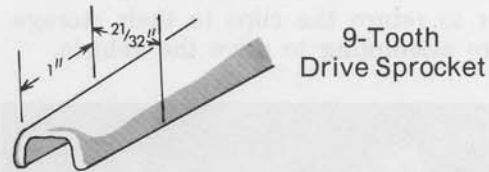

9-Tooth Drive Sprocket

7-Tooth Drive Sprocket

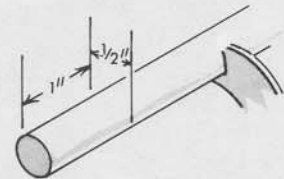

### Towing Instructions

The sprocket lock cylinder must be loosened and moved away from the drive sprocket in order to tow the vehicle.

This can be done by simply removing the two bolts at the rear of the sprocket lock cylinder.



**SAFETY WARNING: VEHICLE MUST BE ON LEVEL GROUND OR TURNED SIDWAYS, IF ON A SLOPE, [SEE PARKING INST. PAGE 11] BEFORE REMOVAL OF SPROCKET LOCK CYLINDER TO MINIMIZE POSSIBILITY OF UNIT RUNNING AWAY OUT OF CONTROL.**

It is recommended that the sprocket lock cylinder be secured to the machine (wired, taped, etc.) to prevent damage or loss while towing.



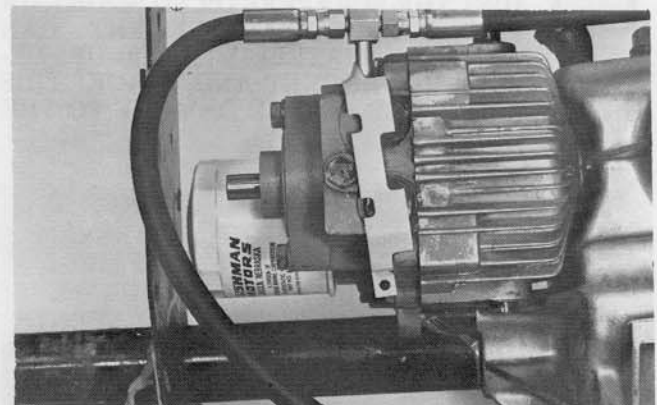

**NOTE: IT IS NOT NECESSARY TO DISCONNECT ANY PART OF THE HYDRAULIC SYSTEM TO REMOVE THE SPROCKET LOCK CYLINDER FOR TOWING.**

Each hydrostatic transmission is equipped with two valves which release the hydraulic fluid pressure. Should the vehicle require moving, install the towing clips as shown below. With the clips in the moving position, the TRACKSTER can be moved up to 500 yards at speeds not to exceed 5 m.p.h. Never exceed these limits or hydrostats may be damaged.

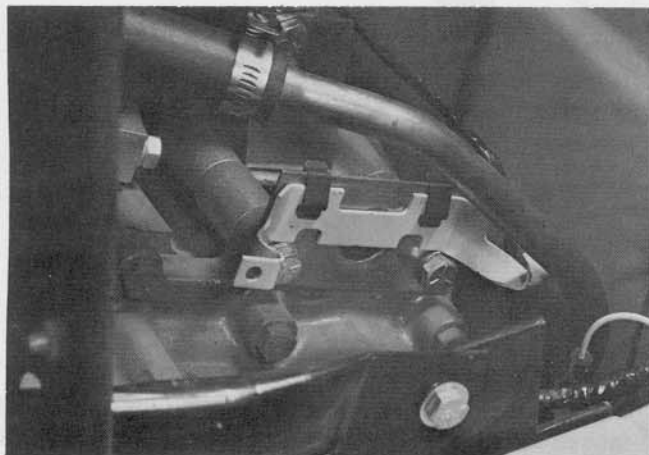

Remember to return the clips to their storage position before attempting to drive the vehicle.



 **NOTE:** NEVER MOVE VEHICLE WHEN ENGINE IS NOT RUNNING UNLESS CLIPS HAVE BEEN INSTALLED. THIS INCLUDES SUCH THINGS AS PUSHING THE VEHICLE AROUND BY HAND AND BACKING THE VEHICLE OFF OF TILT TRAILERS.

 **SAFETY WARNING:** DO NOT REMOVE CLIPS WHILE ENGINE IS RUNNING.

 **SAFETY WARNING:** SPROCKET LOCK MUST BE RE-INSTALLED AND ADJUSTED IN ACCORDANCE WITH CUSHMAN INSTALLATION INSTRUCTION SHEET NO. 823870. IF YOU DO NOT HAVE THE CORRECT INSTRUCTIONS, REQUEST THEM FROM ADDRESS SHOWN ON INSIDE FRONT COVER.

### DRIVE SPROCKET SCRAPER ADJUSTMENT 7-TOOTH SPROCKETS ONLY

After correctly adjusting the tracks, the sprocket scrapers should be adjusted to be  $\frac{1}{4}$ " from the sprockets (above right). Torque all nuts to 38 ft. lbs.

 **NOTE:** FAILURE TO CORRECTLY ADJUST THE SCRAPERS OR TO MAINTAIN THE CORRECT ADJUSTMENT CAN LEAD TO MATERIAL BUILD-UP BETWEEN SPROCKET AND TRACK. THIS CAN CAUSE SEVERE DAMAGE TO THE DRIVE ASSEMBLY.

 **SAFETY WARNING:** IF CHANGE IS MADE FROM NINE TOOTH TO SEVEN TOOTH DRIVE SPROCKETS, SPROCKET LOCK CYLINDER MUST BE RE-MOUNTED IN FORWARD MOUNTING HOLES. FAILURE TO RE-LOCATE CYLINDER WILL RESULT IN COMPLETE FAILURE OF SPROCKET LOCK.

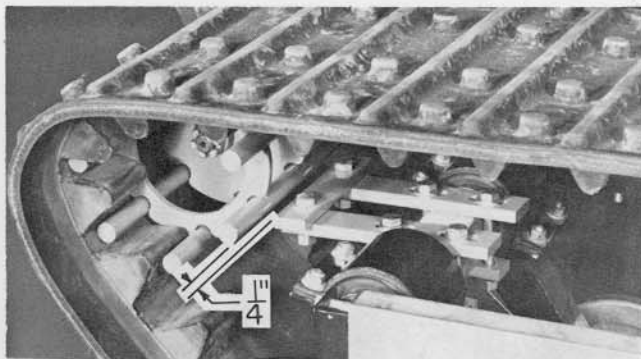

**SAFETY WARNING:** REMOVAL OF SCRAPER ASSEMBLY COULD RENDER SPROCKET LOCK INEFFECTIVE.

### VEHICLE STORAGE

Before the vehicle is put into storage for any period exceeding 30 days, the following steps should be taken:

1. Drain and clean the fuel tank. Remove the tank from the vehicle and flush out with clean gasoline.
2. Crank or run engine to remove the fuel from all lines and the carburetor.
3. Crank engine and inject rust preventive oil into carburetor.
4. Remove spark plugs and squirt a small amount of oil into each cylinder. Turn the engine over several times by hand to distribute the oil. Replace the spark plugs.
5. Remove the battery from the vehicle. Store the battery in a cool, dry area where it can be recharged to maintain a fully charged condition.



**SAFETY WARNING:** WHEN REPLACING ANY BOLT, SCREW, OR OTHER FASTENER, USE ONLY ORIGINAL EQUIPMENT REPLACEMENT PARTS OR PARTS OF EQUIVALENT STRENGTH AND MATERIAL.



**SAFETY WARNING:** WHEN RE-USING LOCKNUTS BE SURE THEY FIT TIGHTLY. LOCKNUTS REMOVED AND REPLACED MORE THAN A FEW TIMES CAN LOSE SOME OF THEIR LOCKING ABILITY. IF THERE IS ANY DOUBT AS TO THEIR CONDITION, THEY SHOULD BE REPLACED WITH NEW PARTS.

# WATER OPERATION SECTION

Due to the special nature of the Marsh Model Trackster, the following information is of extreme importance. Please read it carefully. If any part of this section is not clear, contact us at the address shown on the inside front cover before operating the vehicle in water.



**SAFETY WARNING: DO NOT OPERATE THE TRACKSTER IN WATER UNTIL YOU ARE WELL ACQUAINTED WITH DRY LAND OPERATION OF THE UNIT, AND HAVE READ THIS OPERATING SECTION CAREFULLY.**

Operating the Trackster in shallow water (water level no higher than top tread) is basically the same as normal operation. Slight variations in T-handle response due to underwater conditions (mud, weeds, moss, etc.) may be noted, but should present no difficulty to an operator using normal techniques.

THE TRACKSTER SHOULD NOT BE OPERATED IN DEEP WATER. If tracks lose contact with underwater terrain (vehicle begins to float), maneuverability and T-handle response will be lost.



**SAFETY WARNING: THE MARSH MODEL TRACKSTER IS NOT DESIGNED AS, OR INTENDED TO BE, A BOAT. THE BUOYANT CHARACTERISTICS OF THE VEHICLE ARE INTENDED AS A SAFETY FEATURE ONLY. THE BUOYANCY OF THE UNIT DECREASES RAPIDLY WITH THE ADDITION OF WATER INSIDE THE ENGINE OR PASSENGER COMPARTMENT. THE VEHICLE CAN SINK IF WATER IS ALLOWED TO ACCUMULATE IN THESE AREAS.**

The following safety guidelines should be followed at all times when operating the Marsh Model Trackster in water.

A. Always enter and exit water, no matter how deep, very slowly and with extreme caution. Enter and exit at the most shallow point and most gradual angle possible.

B. Never assume knowledge of water depth or underwater conditions.

C. Immediately, upon entering water, check for water entering vehicle. If any water entry is noticed, return to dry land and make necessary repairs before re-entering water.

D. When operating vehicle in water above top of tread, occupants should wear U.S. Coast Guard approved lifebelts or jackets.

E. Never carry more than one passenger. If cargo is being carried, distribute it evenly, by weight, as you would if loading a boat. Total load weight, including passenger and operator, must not exceed 600 lbs.

F. Never operate the vehicle in moving water or in still water with a choppy surface. Never enter water during a storm.



**SAFETY WARNING: THE TRACKSTER WILL NOT PROPEL ITSELF AGAINST MOVING WATER WHILE FLOATING.**

G. Never attach any additional power source to the vehicle.

H. The addition of any accessory to the vehicle will affect stability in water and could cancel vehicle's buoyant characteristics.

B-BLACK B/W-BLACK & WHITE BL-BLUE G-GREEN GR-GREY O-ORANGE COLOR CODE P-PURPLE R/Y-RED & YELLOW W-WHITE Y-YELLOW Y/G-YELLOW & GREY

